

TECHNICAL MANUAL
Of
Intel 945GSE Express Chipset
&
Intel FW82801GBM ICH Chipset
Based
Mini-ITX M/B For ATOM Processor

NO.G03-NF94-F

Rev 2.0

Release date: Feb., 2009

Trademark:

* Specifications and Information contained in this documentation are furnished for information use only, and are subject to change at any time without notice, and should not be construed as a commitment by manufacturer.

Environmental Protection Announcement

Do not dispose this electronic device into the trash while discarding. To minimize pollution and ensure environment protection of mother earth, please recycle.



TABLE OF CONTENT

USER'S NOTICE	iii
MANUAL REVISION INFORMATION	iii
ITEM CHECKLIST	iii
CHAPTER 1 INTRODUCTION OF VIA CHIPSET MOTHERBOARD	
1-1 FEATURE OF MOTHERBOARD	1
1-2 SPECIFICATION	2
1-3 LAYOUT DIAGRAM & JUMPER SETTING	3
CHAPTER 2 HARDWARE INSTALLATION	
2-1 JUMPER SETTING	7
2-2 CONNECTORS AND HEADERS	11
2-2-1 CONNECTORS	11
2-2-2 HEADERS	12
CHAPTER 3	
3-1 ENTERING SETUP	21
3-2 GETTING HELP	21
3-3 THE MAIN MENU	21
3-4 ADVANCED BIOS FEATURES	24
3-4-1 CPU FEATURE	26
3-5 INTERGRATED PERIPHERALS	27
3-5-1 ONBOARD SUPERIO IO FUNCTION	28
3-6 PC HEALTH STATUS	30
3-7 ADVANCED CHIPSET FEATURES	31
3-8 POWER MANAGEMENT SETTING	32
3-9 PnP/PCI CONFIGURATION	34
3-10 MISCELLANEOUS CONFIGURATION	34



Safety Environmental Instruction

- Avoid the dusty, humidity and temperature extremes. Do not place the product in any area where it may become wet.
- 0 to 60 centigrade is the suitable temperature. (The figure comes from the request of the main chipset)
- Generally speaking, dramatic changes in temperature may lead to contact malfunction and crackles due to constant thermal expansion and contraction from the welding spots' that connect components and PCB. Computer should go through an adaptive phase before it boots when it is moved from a cold environment to a warmer one to avoid condensation phenomenon. These water drops attached on PCB or the surface of the components can bring about phenomena as minor as computer instability resulted from corrosion and oxidation from components and PCB or as major as short circuit that can burn the components. Suggest starting the computer until the temperature goes up.
- The increasing temperature of the capacitor may decrease the life of computer. Using the close case may decrease the life of other device because the higher temperature in the inner of the case.
- Attention to the heat sink when you over-clocking. The higher temperature may decrease the life of the device and burned the capacitor.

USER'S NOTICE

COPYRIGHT OF THIS MANUAL BELONGS TO THE MANUFACTURER. NO PART OF THIS MANUAL, INCLUDING THE PRODUCTS AND SOFTWARE DESCRIBED IN IT MAY BE REPRODUCED, TRANSMITTED OR TRANSLATED INTO ANY LANGUAGE IN ANY FORM OR BY ANY MEANS WITHOUT WRITTEN PERMISSION OF THE MANUFACTURER.

THIS MANUAL CONTAINS ALL INFORMATION REQUIRED TO USE INTEL 945GM CHIPSET MOTHER-BOARD SERIES AND WE DO ASSURE THIS MANUAL MEETS USER'S REQUIREMENT BUT WILL CHANGE, CORRECT ANY TIME WITHOUT NOTICE. MANUFACTURER PROVIDES THIS MANUAL "AS IS" WITHOUT WARRANTY OF ANY KIND, AND WILL NOT BE LIABLE FOR ANY INDIRECT, SPECIAL, INCIDENTAL OR CONSEQUENTIAL DAMAGES (INCLUDING DAMAGES FOR LOSS OF PROFIT, LOSS OF BUSINESS, LOSS OF USE OF DATA, INTERRUPTION OF BUSINESS AND THE LIKE).

PRODUCTS AND CORPORATE NAMES APPEARING IN THIS MANUAL MAY OR MAY NOT BE REGISTERED TRADEMARKS OR COPYRIGHTS OF THEIR RESPECTIVE COMPANIES, AND THEY ARE USED ONLY FOR IDENTIFICATION OR EXPLANATION AND TO THE OWNER'S BENEFIT, WITHOUT INTENT TO INFRINGE.

Manual Revision Information

Reversion	Revision History	Date
2.0	Second Edition	February, 2009

Item Checklist

- Motherboard
- Cable(s)
- CD for motherboard utilities
- Motherboard User's Manual
- Back panel

Chapter 1

Introduction of the Motherboard

1-1 Feature of motherboard

- * Intel 945GSE+ICH7M chipset.
- * Onboard ATOM CPU, with low power consumption never denies high performance.
- * Support FSB 533MHz.
- * Support DDRII 400/533 up to 2GB.
- * Onboard REALTEK RTL 8111C Gigabit Ethernet LAN.
- * Integrated ALC662 6-channel HD audio CODEC
- * Support USB2.0 data transport demands.
- * Support RS232/422/485 and watchdog.

1-2 Specification

Spec	Description
Design	* Mini ITX form factor 6 layers PCB size: 17.0x17.0cm
Chipset	* Intel 945GSE+ICH7M Chipset
Embedded CPU	* ATOM CPU
Memory Socket	* 200-pin DDRII SO-DIMM socket x1 * Support DDRII 400/533MHz system Modules DDRII memory * Expandable to 2GB.
Expansion Slots	* 32-bit PCI slot x 1pcs
Integrate IDE	* One PCI IDE controller that supports PCI Bus Mastering, ATA PIO/DMA and the ULTRA DMA 133/100/66 functions that deliver the data transfer rate up to 100 MB/s.
LAN	* Integrated Realtek RTL8111C PCI-E Gigabit LAN. * Support Fast Ethernet LAN function of providing 10Mb/100Mb/1000Mb Ethernet data transfer rate
Audio	* ALC662 6 channel Audio Codec integrated * Audio driver and utility included
BIOS	* Award 8MB Flash ROM
Multi I/O	* PS/2 keyboard * Hard disk drive connector x1 * SATAII x2 * USB2.0 port x 4 and headers x2 * RJ45 LAN connector x1 * Audio connector x1 (Line-in, Line-out, MIC,SPDIF OUT) * COM connector x 2 * COM Header x2 * LVDS Connector x1

	<ul style="list-style-type: none">* VGA Connector x1* HDTV OUT Connector x1* DVI Connector x1* Parallel Connector x1
--	---

1-3 Layout Diagram & Jumper Setting

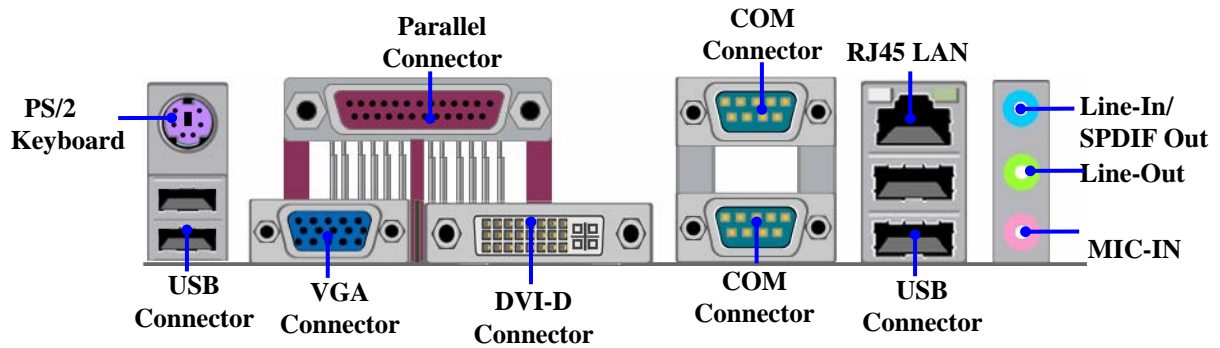

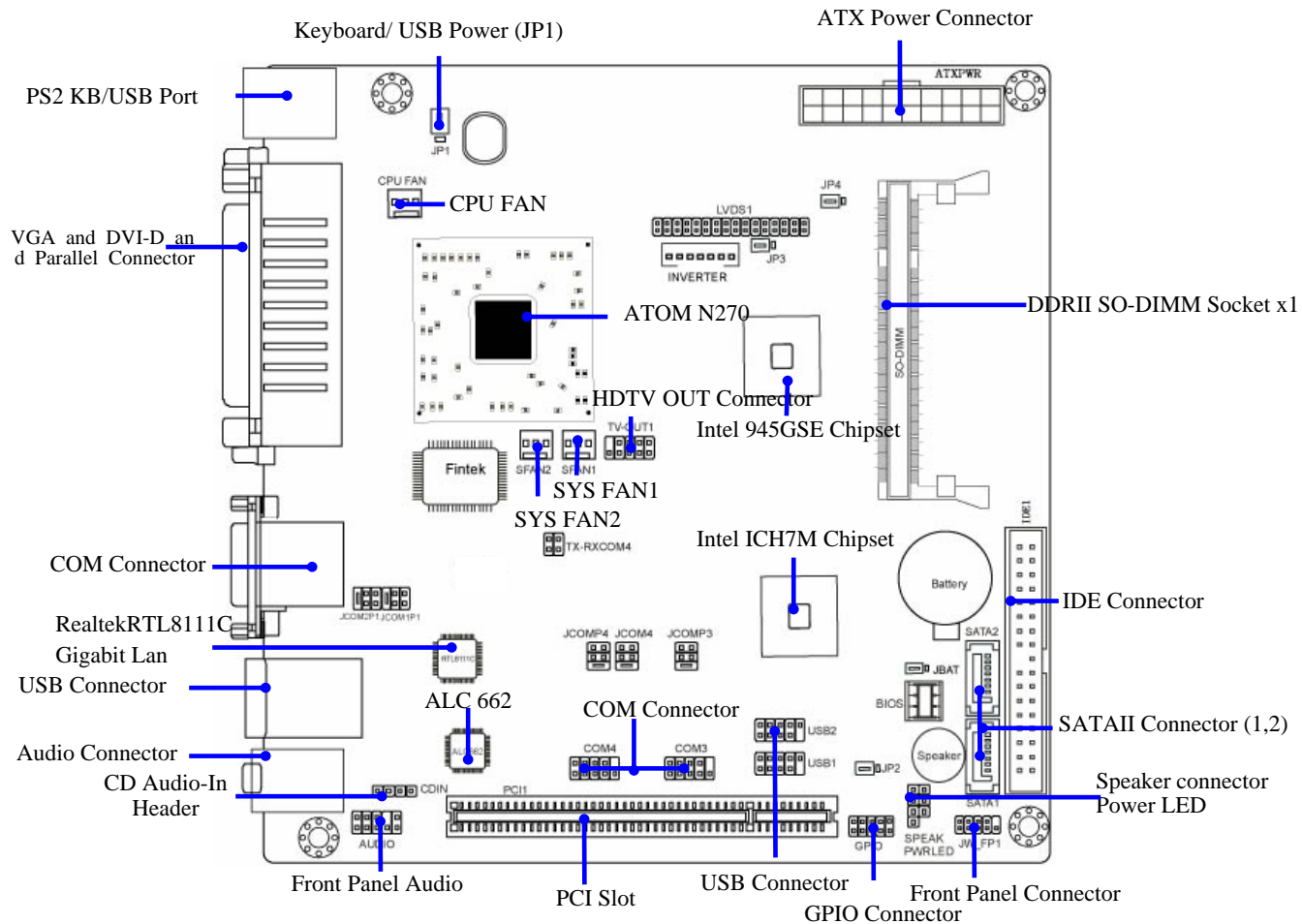

Jumper

Jumper	Name	Description	Page
JP1	KB/USB Power On Function Setting	3-pin Block	P.7
JBAT	CMOS RAM Clear Function Setting	3-pin Block	P.7
JP2	USB Power On Function Setting	3-pin Block	P.8
JP3	Inverter backlight select	3-pin Block	P.8
JP4	LVDS5V/3.3V Select	3-pin Block	P.8
JCOM1P1	Power RS232 Function Select	6pin Block	P.9
JCOM2P1	Power RS232 Function Select	6pin Block	P.9
JCOMP3	Power RS232 Function Select	6pin Block	P.10
JCOMP4	Power RS232 Function Select	6pin Block	P.10
JCOM4	COM4 RS232/422/485 Function Select	6pin Block	P.11

Connectors

Connector	Name	Description	Page
USB	USB Port Connector	4-pin Connector	P.11
UL2	RJ45 LAN Connector	RJ-45 Connector	P.11
VGA	Video Graphic Attach Connector	D-sub15-pin Female	P.11
AUDIO1	Line-Out /MIC/Line-In Audio Connector	3 Phone Jack	P.11
COM1,2	Serial Port COM1 Connector	9-pin Connector	P.11
DVI-D Connector	DVI port connector	24-pin Connector	P.11
Parallel Connector	Parallel port connector	24-pin Connector	P.11

Headers

Header	Name	Description	Page
CPUFAN,SYSFAN1/2	FAN Speed Headers	3-pin Block	P.17
AUDIO1	Front panel audio Headers	9-pin block	P.12
HDTV Out1	HDTV Out Header	9-pin block	
CDIN	CD Audio-In Header	4-pin Block	P.12
PWR LED	Power LED	4-pin Block	P.17
LVDS	LVDS Connector	32-pin Block	P.14
Inverter	LVDS Inverter Connector	7-pin Block	P.15
COM3,4	Serial Port COM3/4 Connector	9-pin Connector	P.17
JW_FP (PWR LED/ HD LED/ /Power Button /Reset)	Front Panel Header (PWR LED/ HD LED/ /Power Button /Reset)	9-pin Block	P.16
ATXPWR	ATX Power Connector	24-pin Block	P.10
SATA1~2	Serial ATAII IDE Connector	7-pin Connector	P.11
GPIO	GPIO header	10-pin Connector	P.18

Chapter 2

2-1 Jumper Setting

(1) JP1: KB/USB Power On Function Setting

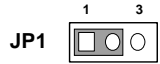
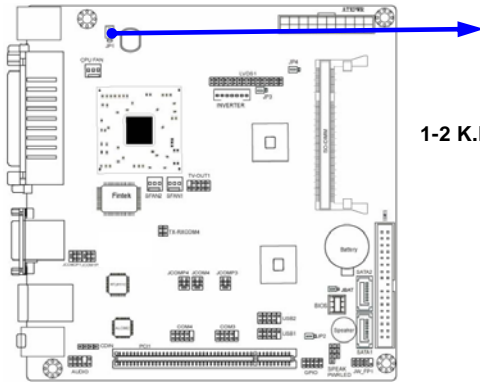

1-2 K.B&USB POWER-ON Disabled

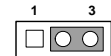

2-3 K.B& USB POWER-ON Enabled

(2) Clear CMOS (3-pin): JBAT

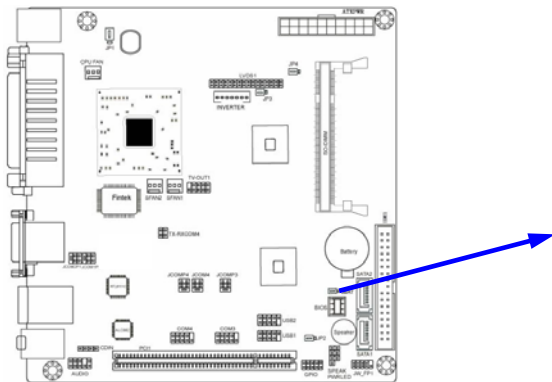

1-2 closed Normal



2-3 closed Clear CMOS

CMOS RAM Clear Setting

(3) JP3: Inverter backlights select (3-pin)

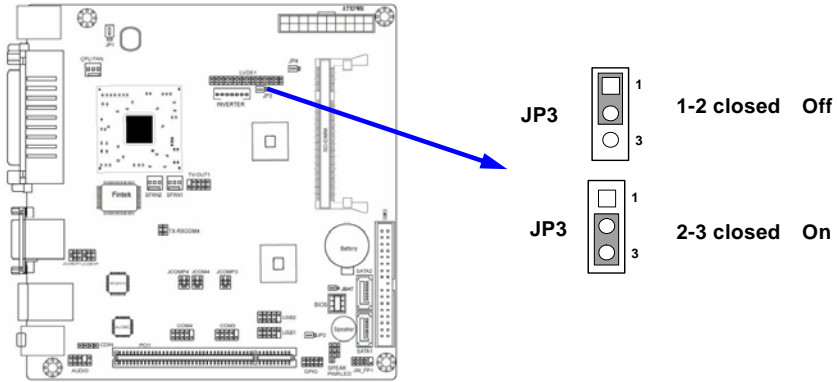

(4) JP4: LVDS 5V/3.3V Function setting (3-pin)

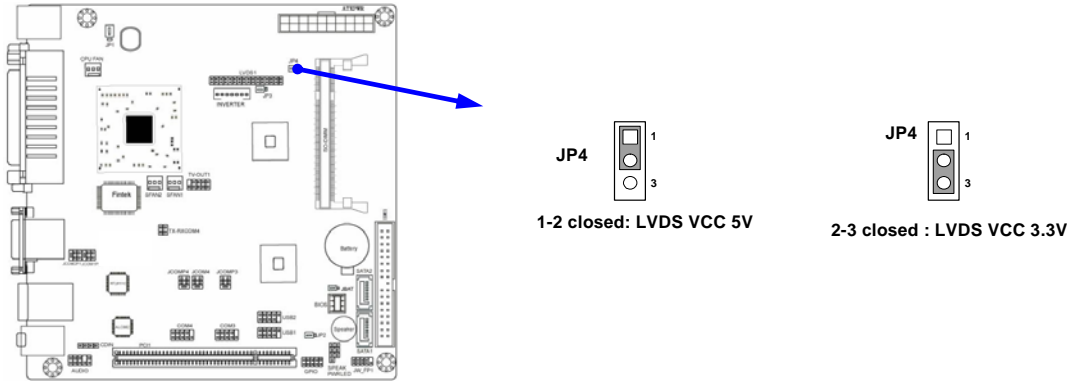

(5) JCOM1P1: COM1 Pin 9 function select

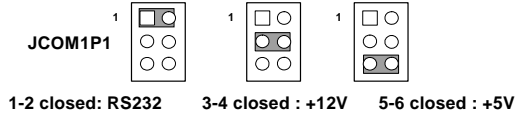
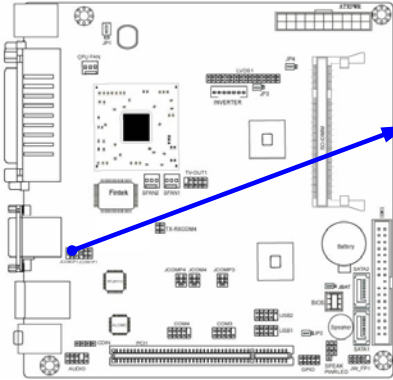

(6) JCOM2P1: COM2 Pin9 function select

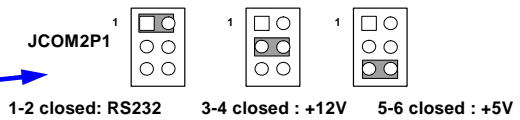
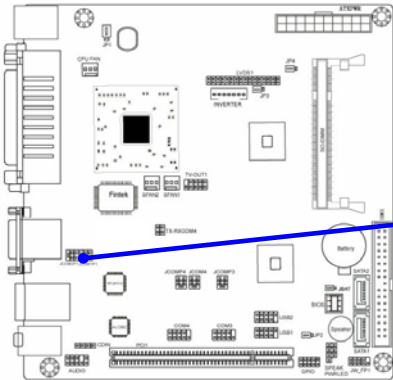

(7) JCOM4: Power RS232/422/485 Function Select

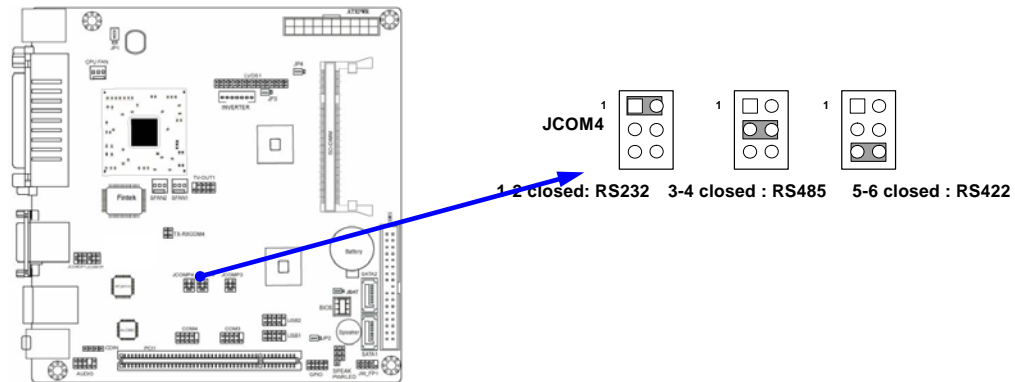

(8) JCOMP4: COM4 Pin9 function select

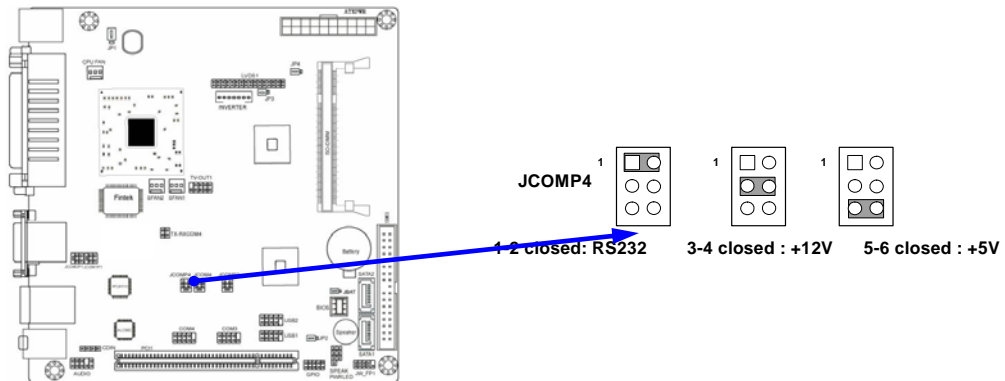

(9) JCOMP3: COM3 Pin9 function select

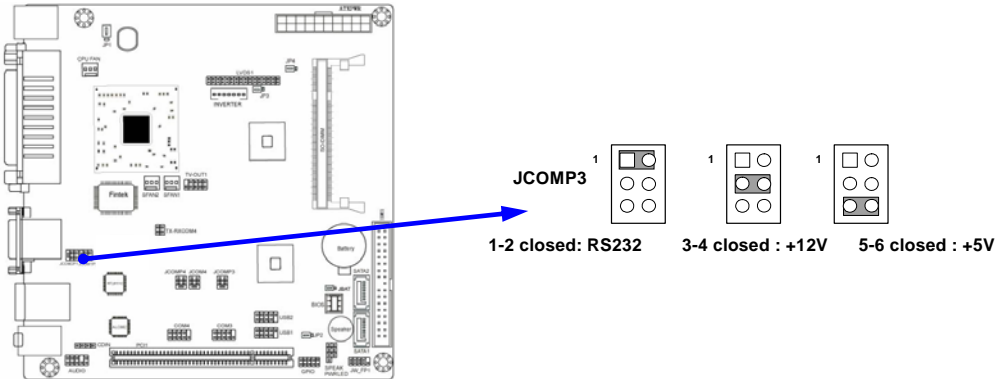

2-2 Connectors and Headers

2-2-1 Connectors

(1) Audio Connector: (Line-IN/ Line-Out/ MIC-In)

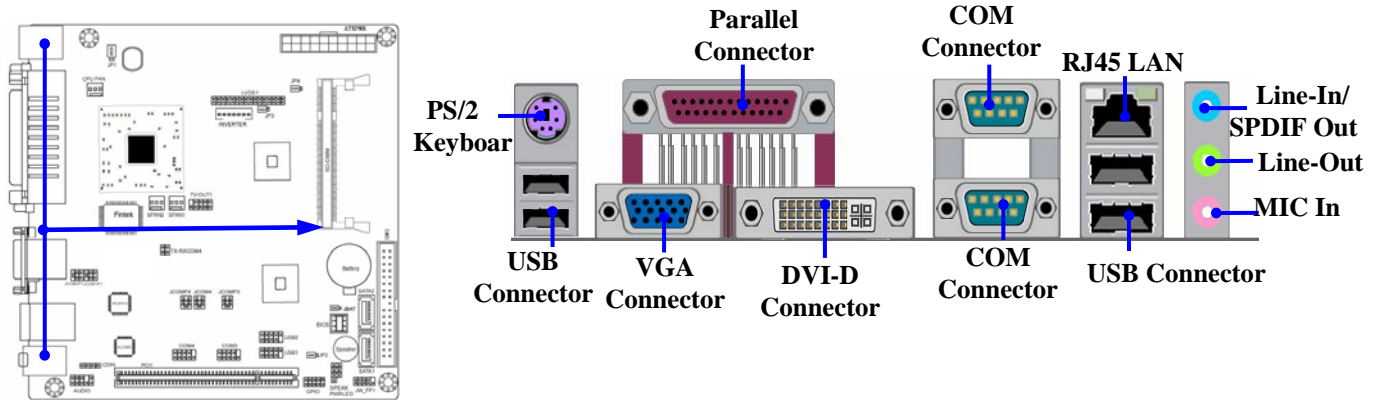

(2) Serial-ATA Port connector: SATA1/SATA2

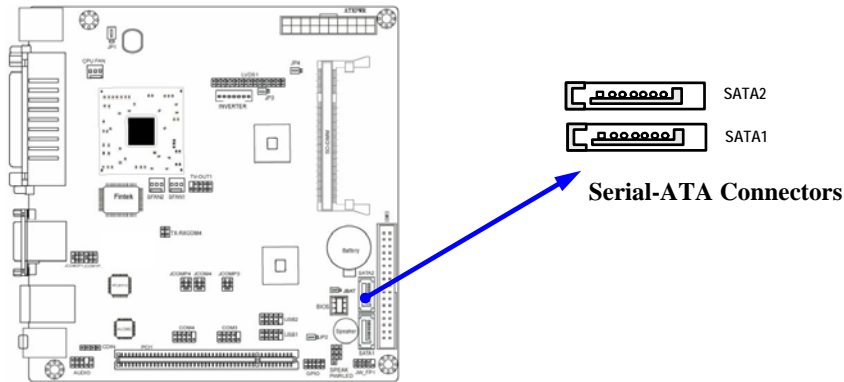

2-2-2 Headers

(1) Front panel audio (9-pin): AUDIO1

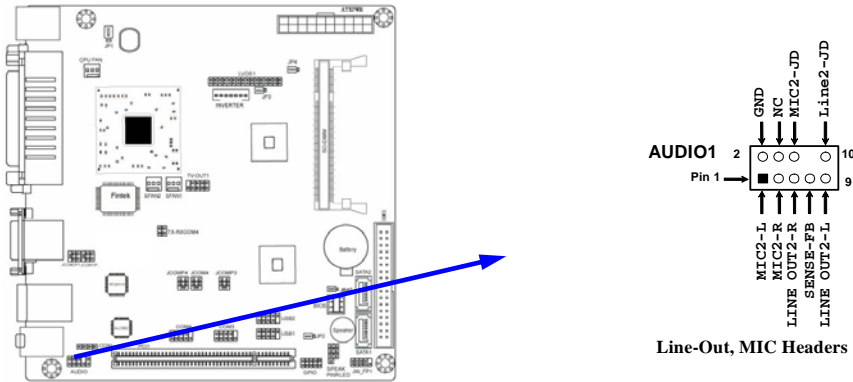

(2) CD AUDIO-In Headers (4-pin): CDIN

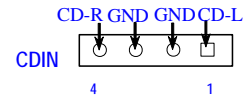
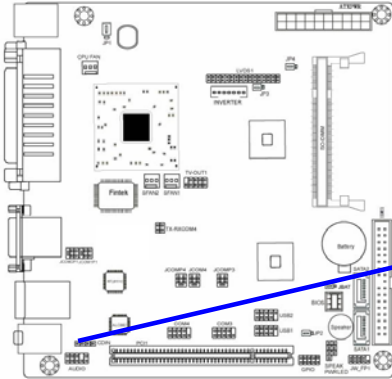

CD Audio-In Headers

(3) LVDS Headers: LVDS

Pin NO.	Pin Define	Pin NO.	Pin Define
Pin 1	NC	Pin 2	NC
Pin 3	LVDS_CLKBN	Pin 4	LVDS_CLKBP
Pin 5	LVDSA_DATAN2	Pin 6	LVDSA_DATAP2
Pin 7	LVDSA_DATAN1	Pin 8	LVDSA_DATAP1
Pin 9	LVDSA_DATAN0	Pin 10	LVDSA_DATAP0
Pin 11	LVDS_DDC_DATA	Pin 12	LVDS_DDC_CLK
Pin 13	GND	Pin 14	GND
Pin 15	GND	Pin 16	GND
Pin 17	NC	Pin 18	NC
Pin 19	LVDS_CLKAP	Pin 20	LVDS_CLKAN
Pin 21	LVDSB_DATAP2	Pin 22	LVDSB_DATAN2

Pin 23	LVDSB_DATAP1	Pin 24	LVDSB_DATAN1
Pin 25	LVDSB_DATAP0	Pin 26	LVDSB_DATAN0
Pin 27	PVDD	Pin 28	PVDD
Pin 29	PVDD	Pin 30	PVDD
Pin 31	GND	Pin 32	GND

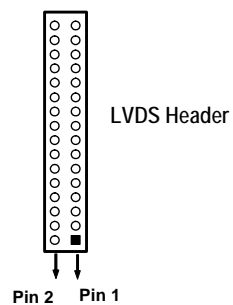
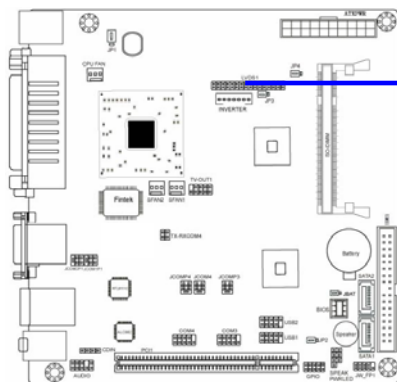

(4) Pin-headers of LVDS Inverter:

Pin 1 and pin2: VCC of inverter

Pin3、pin4 and pin6: GND

Pin5: Backlight

Pin7: Brightness

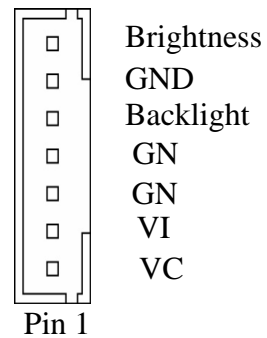
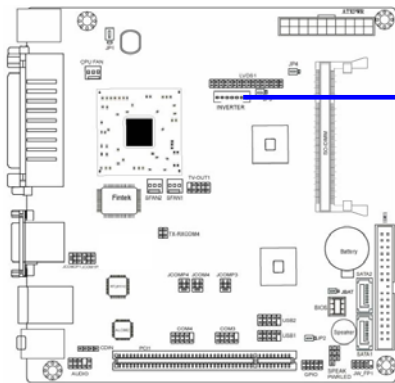

(5) HDTV-OUT1 Header:

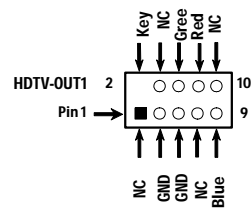
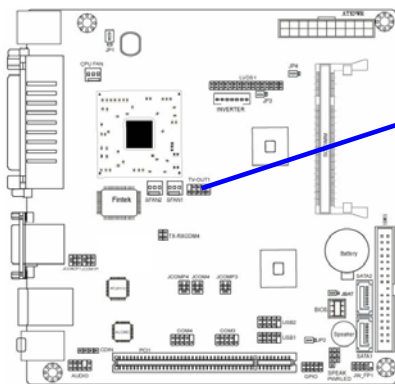

HDTV-OUT Header

(6)TX-RXCOM4 Header:

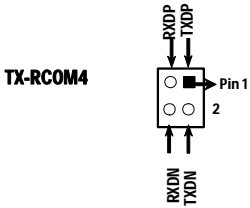
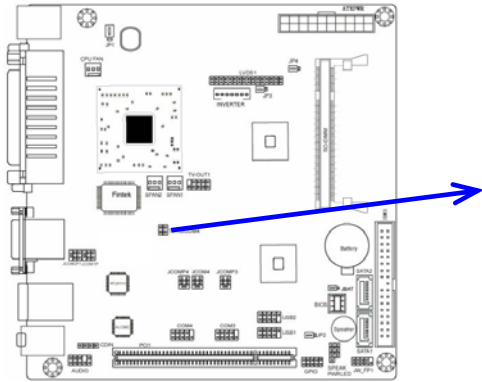

TX-RXCOM4 Header

(7) JW-FP (9-pin)

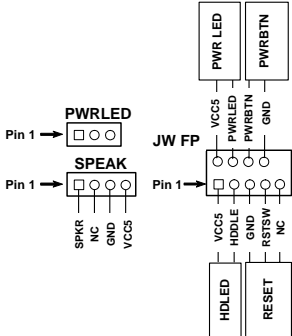
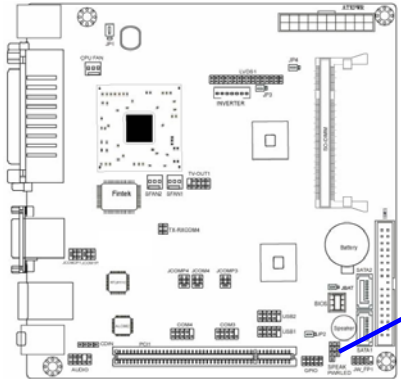

System Case Connections

(8) FAN Speed Headers (3-pin): CPUFAN, SFAN1/SFAN2

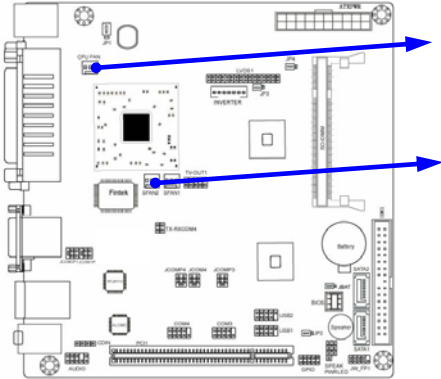

Pin 1  CPUFAN

Pin 1  SYS FAN1

Pin 1  SYS FAN2

(9) COM Connectors (9-pin):

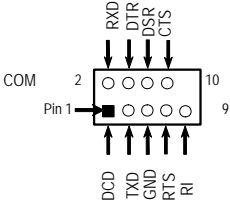
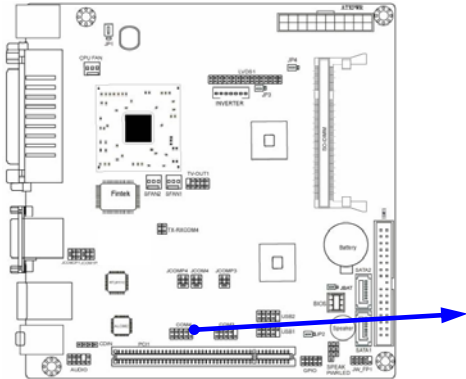

COM Connector

(10) GPIO Connectors (9-pin):

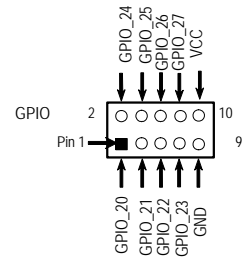
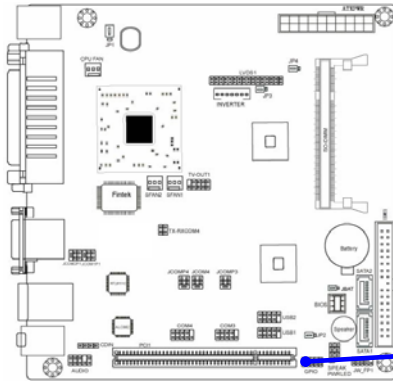

GPIO Connector

Chapter 3

Introducing BIOS

Attention: The BIOS options shown in this manual is for reference use only. We reserve the right to update the BIOS version without advance notice.

The BIOS is a program located on a Flash Memory on the motherboard. This program is a bridge between motherboard and operating system. When you start the computer, the BIOS program will gain control. The BIOS first operates an auto-diagnostic test called POST (power on self test) for all the necessary hardware, it detects the entire hardware device and configures the parameters of the hardware synchronization. Only when these tasks are completed done it gives up control of the computer to operating system (OS). Since the BIOS is the only channel for hardware and software to communicate, it is the key factor for system stability, and in ensuring that your system performance as its best.

In the BIOS Setup main menu of Figure 3-1, you can see several options. We will explain these options step by step in the following pages of this chapter, but let us first see a short description of the function keys you may use here:

- Press <Esc> to quit the BIOS Setup.
- Press ↑↓←→ (up, down, left, right) to choose, in the main menu, the option you want to confirm or to modify.
- Press <F10> when you have completed the setup of BIOS parameters to save these parameters and to exit the BIOS Setup menu.
- Press Page Up/Page Down or +/- keys when you want to modify the BIOS parameters for the active option.

3-1 Entering Setup

Power on the computer and by pressing immediately allows you to enter Setup.

If the message disappears before you respond and you still wish to enter Setup, restart the system to try again by turning it OFF then ON or pressing the “RESET” button on the system case. You may also restart by simultaneously pressing <Ctrl>, <Alt> and <Delete> keys. If you do not press the keys at the correct time and the system does not boot, an error message will be displayed and you will again be asked to

Press <F1> to continue, or to enter Setup

3-2 Getting Help

Main Menu

The on-line description of the highlighted setup function is displayed at the bottom of the screen.

Status Page Setup Menu/Option Page Setup Menu

Press F1 to pop up a small help window that describes the appropriate keys to use and the possible selections for the highlighted item. To exit the Help Window, press <Esc>.

3-3 The Main Menu

Once you enter Award® BIOS CMOS Setup Utility, the Main Menu (Figure 3-1) will appear on the screen. The Main Menu allows you to select from fourteen setup functions and two exit choices. Use arrow keys to select among the items and press <Enter> to accept or enter the sub-menu.

Phoenix - AwardBIOS CMOS Setup Utility

Standard CMOS Features	Miscellaneous Control
Advanced BIOS Features	Load Optimized Defaults
Advanced Chipset Features	Load standard Defaults
Integrated Peripherals	Set Supervisor Password
Power Management Setup	Set User Password
PnP/PCI Configurations	Save & Exit Setup
PC Health Status	Exit Without Saving
Esc : Quit F9 : Menu in BIOS ↑↓→← : Select Item	
F10 : Save & Exit Setup	

Figure 3-1

Standard CMOS Features

Use this Menu for basic system configurations.

Advanced BIOS Features

Use this menu to set the Advanced Features available on your system.

Advanced Chipset Features

Use this menu to change the values in the chipset registers and optimize your system's performance.

Integrated Peripherals

Use this menu to specify your settings for integrated peripherals.

Power Management Setup

Use this menu to specify your settings for power management.

Miscellaneous Control

Use this menu to specify your settings for **Miscellaneous Control**.

PC Health Status

This entry shows your PC health status.

Power User Overclock Settings

Use this menu to specify your settings (frequency, Voltage) for overclocking demand

CPU Thermal Throttling Setting

The selection is set for activating the active CPU Thermal Protection by flexible CPU loading adjustment in the arrange of temperature you defined.

Load Optimized Defaults

Use this menu to load the BIOS default values these are setting for optimal performances system operations for performance use.

Password Settings

This entry for setting Supervisor password and User password

Save & Exit Setup

Save CMOS value changes to CMOS and exit setup.

Exit Without Saving

Abandon all CMOS value changes and exit setup.

3-4 Advanced BIOS Features

Phoenix - AwardBIOS CMOS Setup Utility

Advanced BIOS Features

Virus Warning	Disabled	Item Help	
CPU L3 Cache	Enabled		
CPU Feature	Press Enter	Menu Level >	
Hard Disk Boot Priority	Press Enter		
Hyper Disk Boot Priority	Enabled		
Quick power on self Test	Enabled		
First Boot Device	HARD DISK		
Second Boot Device	CDROM		
Third Boot Device	Disabled		
Boot other Device	Enabled		
Boot Up NumLock Status	On		
Typematic Rate Setting	Disabled		
Typematic Rate (Chars/Sec)	6		
Typematic Delay (Msec)	250		
Security Option	Setup		
APIC Mode	Enabled		
MPS Version Control For OS	1.4		
OS Select For DRAM > 64MB	Non-OS2		
HDD S.M.A.R.T. Capability	Disabled		
Report No FDD For Windows	Yes		
↑↓←→ Move Enter:Select +/-/PU/PD:Value F10:Save ESC:Exit F1:General Help F5:Previous Values F6:Optimized Defaults F7:Standard Defaults			

Hard Disk Boot Priority

The selection is for you to choose the hard disk drives priorities to boot from.

Virus Warning

The selection Allow you to choose the VIRUS Warning feature for IDE Hard Disk boot sector protection. If this function is enabled and someone attempt to write data into this area, BIOS will show a warning message on screen and alarm beep.

Disabled (default) No warning message to appear when anything attempts to access the boot sector or hard disk partition table.

Enabled Activates automatically when the system boots up causing a warning message to appear when anything attempts to access the boot sector of hard disk partition table.

CPU Internal Cache

The default value is Enabled.

Enabled (default) Enable cache

Disabled Disable cache

Note: The internal cache is built in the processor.

External Cache

Choose Enabled or Disabled. This option enables the Level 2 cache memory.

Quick Power On Self-Test

This category speeds up Power On Self Test (POST) after you power on the computer. If this is set to Enabled, BIOS will shorten or skip some check items during POST.

Enabled (default) Enable quick POST

Disabled Normal POST

First/Second/Third Boot Device

The BIOS attempts to load the operating system from the devices in the sequence selected in these items. The settings are Floppy, LS/ZIP, HDD-0/HDD-1/HDD-3, SCSI, CDROM, LAD and Disabled.

Boot Up Floppy Seek

During POST, BIOS will determine if the floppy disk drive installed is 40 or 80 tracks. 360K type is 40 tracks while 760K; 1.2M and 1.44M are all 80 tracks.

Boot Up NumLock Status

The default value is on.

On (default) Keypad is numeric keys.

Off Keypad is arrow keys.

Typematic Rate Setting

Keystrokes repeat at a rate determined by the keyboard controller. When enabled, the typematic rate and typematic delay can be selected. The settings are: Enabled/Disabled.

Typematic Rate (Chars/Sec)

Set the number of times a second to repeat a keystroke when you hold the key down. The settings are: 6, 8, 10, 12, 15, 20, 24, and 30.

Typematic Delay (Msec)

Sets the delay time after the key is held down before beginning to repeat the keystroke. The settings are 250, 500, 750, and 1000.

Security Option

This category allows you to limit access to the system and Setup, or just to Setup.

- | | |
|------------------------|---|
| System | The system will not boot and access to Setup will be denied if the correct password is not entered at the prompt. |
| Setup (default) | The system will boot, but access to Setup will be denied if the correct password is not entered prompt. |

HDD S.M.A.R.T Capability

This option allow you to enable the HDD S.M.A.R.T Capability (Self-Monitoring, Analysis and Reporting Technology) . You can choose from Enabled and Disabled.

MPS Version Control For OS 1.4

This option is only valid for multiprocessor motherboards as it specifies the version of the Multiprocessor Specification (MPS) that the motherboard will use.

OS Select For DRAM > 64MB

Allows OS2[®] to be used with >64MB or DRAM. Settings are Non-OS/2 (default) and OS2. Set to OS/2 if using more than 64MB and running OS/2[®].

3-4-1 CPU Feture

Phoenix - AwardBIOS CMOS Setup Utility

CPU Features

Limit CPUID Maxval	Disabled	Item Help
Enhanced Intel Speedstep Tech	Enabled	Menu Level >
↑↓→← Move Enter:Select +/-/PU/PD:Value F10:Save ESC:Exit F1:General Help F5:Previous Values F6:Optimized Defaults F7:Standard Defaults		

Limit CPUID Maxval

This option support the max ID of comparatively old processor.

Enhanced Intel Speedstep Tech

This option can provide average power savings depending on system usage and design.

3-5 Intergrated peripherals

Phoenix - AwardBIOS CMOS Setup Utility Intergrated peripheral

Onboard IDE Function	Press Enter	Item Help
Onboard Device Function	Press Enter	
Onboard Superio Function	Press Enter	Menu Level >>
PWR Status after PWR Failure	Always Off	
Init Display First	PCI Slot	
↑↓→← Move Enter:Select +/-/PU/PD:Value F10:Save ESC:Exit F1:General Help F5:Previous Values F6:Optimized Defaults F7:Standard Defaults		

Phoenix - AwardBIOS CMOS Setup Utility Onboard Device Function

Onboard PCIE Lan Controller	Enabled	Item Help
Onboard PCIE Lan BootRom	Disabled	
High Definition Audio	Enabled	Menu Level >>
USB Host Controller	Enabled	
USB 2.0 Function	Enabled	
USB Keyboard Legacy Support	Disabled	
USB Mouse Legacy Support	Disabled	
USB Storage Legacy Support	Enabled	
↑↓→← Move Enter:Select +/-/PU/PD:Value F10:Save ESC:Exit F1:General Help F5:Previous Values F6:Optimized Defaults F7:Standard Defaults		

Onboard HD Audio

This item allows you to decide to enable/disable the chipset family to support HD Audio. The settings are: Enabled, Disabled.

Onboard PCIE LAN Bootrom

Decide whether to invoke the boot ROM of the onboard LAN chip.

3-5-1 Onboard Super IO Function

Phoenix - AwardBIOS CMOS Setup Utility

Onboard Super IO Function

Onboard Serial Port1	3F8/IRQ4	Item Help	
Onboard Serial Port2	2F8/IRQ3		
UART2 Mold Select	Normal	Menu Level >>	
*IR Duplex Mold	Half		
Add-on Serial port 3	3E8/IRQ4		
Add-on Serial port 3 Mode	RS232		
Add-on Serial port 4	3E8/IRQ4		
Add-on Serial port 4 Mode	RS232		
Onboard Parallel Port	3F8/IRQ7		
Parallel Port Mold	SPP		
*ECP Mold Use DMA	3		
Watchdog Timer Select	Disabled		
*Watchdog Timer Value	255		
*WATCHDOG Timer Unit	Sec.		
↑↓→← Move Enter:Select +/-/PU/PD:Value F10:Save ESC:Exit F1:General Help F5:Previous Values F6:Optimized Defaults F7:Standard Defaults			

Onboard Serial Port 1/2

The optional settings are : Disabled, 3F8/IRQ4 , 2F8/IRQ3, 3E8/IRQ4 , 2E8/IRQ3, and Auto.

UART2 Mode Select

This item allows you to determine which InfraRed(IR) function of the onboard I/O chip. The optional settings are Normal and IrDA.

Onboard Parallel Port

The optional settings are: Disabled, 378/IRQ7, 278/IRQ5 and 3BC/IRQ7.

Parallel Port Mode

- SPP : Standard Parallel Port
- ECP : Enhanced Com Port
- EPP : Enhanced Parallel Port

SPP/ ECP +EPP 1.7/ EPP 1.9

To operate the onboard parallel port as Standard Parallel Port only, choose “SPP.” To operate the onboard parallel port in the EPP modes simultaneously, choose “EPP.” By choosing “ECP”, the onboard parallel port will operate in ECP mode only. Choosing “ECP+EPP” will allow the onboard parallel port to support both the ECP and EPP modes simultaneously. The ECP mode has to use the DMA channel, so choose the onboard parallel port with the ECP feature. After selecting it, the following message will appear: “ECP Mode Use DMA” at this time, the user can choose between DMA channels 3 to 1. The onboard parallel port is EPP Spec. compliant, so after the user chooses the onboard parallel port with the EPP function, the following message will be displayed on the screen: “EPP Mode Select.” At this time either EPP 1.7 spec. or EPP 1.9 spec. can be chosen.

Watchdog Timer Select

This item is used to activate the watchdog function. The optional settings are: Enabled; Disabled. When set it as Enabled user can choose configuration figures in subitems.

Watchdog Timer Value

This item is only activated when Watchdog Timer Select is set as Enabled and users can set a value from the range of 0~255

Watchdog Timer Unit

This item is only activated when Watchdog Timer Select is set as Enabled and the optional units are: Sec. and Min.

***Note: User needs an additional Watchdog Programming Reference Code to make use of this BIOS function. Detailed procedures please download from our website if necessary.**

3-6 PC Health Status

This section shows the Status of you CPU, Fan, and Warning for overall system status. This is only available if there is Hardware Monitor onboard.

Phoenix - AwardBIOS CMOS Setup Utility

PC Health Status

Shutdown Temperature	Disabled	Item Help
CPU Thermal-Throttling	Disabled	
CPU Thermal-Throttling Temp	70c	Menu Level >
CPU Thermal-Throttling Duty	50%	
CPU Thermal-Throttling Beep	Enabled	
Show PCHHealth in POST	Enabled	
Smart fan configurations	Press Enter	
VCC 3V	3.42V	
Vcore	1.16V	
NB	1.03V	
+5v	5.04v	
+12v	12.14V	
+5VSB	5.08V	
VDIMM	1.76V	
VSB 3V	3.37V	
3.3 SUS	3.34V	
VBAT	3.29V	
CPU Temperature	43c/107F	
SYS Temperature	46c/114F	
CPU FAN Speed	0RPM	
SYS FAN1 Speed	0RPM	
SYS FAN2 Speed	0RPM	
↑↓← Move Enter:Select +/-/PU/PD:Value F10:Save ESC:Exit F1:General Help F5:Previous Values F6:Optimized Defaults F7:Standard Defaults		

Show PC Health in Post

During Enabled, it displays information list below. The choice is either Enabled or Disabled

CPU Smart FAN Configurations

CPU Full-Speed Temp

This item allows you setting the FAN works in full speed when the temperature over the value which out set. If the temperature below the value but over the Idle Temperature, the FAN will works over 60% of full speed, and the higher temperature will gain higher FAN speed, after over the temperature which this item setting, the FAN works in full speed.

CPU Idle Temp

This item allows you setting the FAN works in 60% of full speed, when the temperature lower than the temperature which you setting.

Current CPU Temperature/Current System Temp/Current FAN1, FAN2 Speed/Vcore/Vdd/3.3V/+5V/+12V/-12V/VBAT(V)/5VSB(V)

This will show the CPU/FAN/System voltage chart and FAN Speed.

3-7 Advanced Chipset Features

The Advanced Chipset Features Setup option is used to change the values of the chipset registers. These registers control most of the system options in the computer.

Phoenix - AwardBIOS CMOS Setup Utility

Advanced Chipset Features

DRAM Timing selectable	By SPD	Menu Level >
SDRAM CAS Latency Time	Auto	
SDRAM Cycle Time	Auto	
SDRAM RAS-to-CAS Delay	Auto	
SDRAM RAS Precharge Time	Auto	
System BIOS Cachable	Enabled	
Video BIOS Cachabled	Enabled	
Memory Hole at 15M-16M	Disabled	
VGA SETTING		
Onchip Fram Buffer Size	8MB	
Dvmt Mode	DVMT	
DVMT/FI x ED Memory Size	128MB	
Boot Display	Auto	
Panel Number	800*600	
TV Standard	Off	
↑↓→← Move Enter: Select +/-/PU/PD: Value F10:Save ESC: Exit F1:General Help F5:Previous Values F6:Optimized Defaults F7:Standard Defaults		

System BIOS Cacheable

Selecting Enabled allows caching of the system BIOS ROM at F0000h-FFFFFh, resulting in better system performance. However, if any program writes to this memory area, a system error may result. The settings are: Enabled and Disabled.

3-8 Power Management Setup

The Power Management Setup allows you to configure your system to most effectively save energy saving while operating in a manner consistent with your own style of computer use.

Phoenix - AwardBIOS CMOS Setup Utility

Power Management Setup

ACPI Function	Enabled	Item Help
ACPI Suspend Type	S1(pos)	
Power Management	USER Define	Menu Level >
Video off Method	V/H SYNC+Blank	
Video off Suspend	Yes	
MODEN USE IRQ	3	
Suspend Mode	Disabled	
Soft-off by PWR-BTTN	Instant-off	
Wake-up by PCI card	Disabled	
Power on by ring	Disabled	
Wake up by USB KB from S3(S4)	Disabled	
PS2 KB/MS Wake-up from S3-S5	Disabled	
Resume by Alarm	Disabled	
Date (of Month) Alarm	0	
Time (hh:mm:ss)Alarm	0:0:0	
PM Timer Reload Events	Press Enter	
PCI Express PM Function	Press Enter	
↑↓→← Move Enter:Select +/-/PU/PD:Value F10:Save ESC:Exit F1:General Help F5:Previous Values F6:Optimized Defaults F7:Standard Defaults		

ACPI Function

This item allows you to Enabled/Disabled the Advanced Configuration and Power Management (ACPI). The settings are Enabled and Disabled.

Video Off Method

This determines the manner in which the monitor is blanked.

DPMS (default) Initial display power management signaling.

Blank Screen This option only writes blanks to the video buffer.

V/H SYNC+Blank This selection will cause the system to turn off the vertical and horizontal synchronization ports and write blanks to the video buffer.

MODEM Use IRQ

If you want an incoming call on a modem to automatically resume the system from a power-saving mode, use this item to specify the interrupt request line (IRQ) that is used by the modem. You might have to connect the fax/modem to the motherboard Wake On Modem connector for this feature to work.

Soft-Off by PWRBTN

Under ACPI (Advanced Configuration and Power management Interface) you can create a software power down. In a software power down, the system can be resumed by Wake up Alarms. This item lets you install a software power down that is controlled by the power Button on your system. If the item is set to Instant-Off, then the power button causes a software power down. If the item is set to Delay 4 Sec, then you have to hold the power button down for four seconds to cause a software power down.

3-9 PnP/PCI Configuration

Phoenix - AwardBIOS CMOS Setup Utility

Pnp/PCI Configuration

IRQ Resources	Press Enter	Item Help
PCI/VGA Palette Snoop	Disabled	
PCI Express Relative Items		Menu Level >
Maximum Payload size	128	
↑↓→← Move Enter:Select +/-/PU/PD:Value F10:Save ESC:Exit F1:General Help F5:Previous Values F6:Optimized Defaults F7:Standard Defaults		

3-10 Miscellaneous Configuration

Phoenix - AwardBIOS CMOS Setup Utility

Miscellaneous Control

CPU Clock Ratio unlock	Enabled	Item Help
CPU Clock Ratio	10X	
Auto Detect PCI Clock	Disabled	Menu Level >
Spread Spectrum	Disabled	
Current Host/PCI Clock is 133/33MHz		
Current DRAM Clock is 533MHz		
DRAM Clock at Next Boot	By SPD(DDR533)	
SB1.5 Select	1.5000v(Default)	
NB 1.05 Select	1.0500v(Default)	
VDIMM Select	1.800v(Default)	
↑↓→← Move Enter:Select +/-/PU/PD:Value F10:Save ESC:Exit F1:General Help F5:Previous Values F6:Optimized Defaults F7:Standard Defaults		

Phoenix - AwardBIOS CMOS Setup Utility

Miscellaneous Control

CPU Clock Ratio unlock	Enabled	Item Help
CPU Clock Ratio	10X	
Auto Detect PCI Clock	Disabled	Menu Level >
Spread Spectrum	Disabled	
Current Host/PCI Clock is 133/33MHz		
Current DRAM Clock is 533MHz		
DRAM Clock at Next Boot	By SPD(DDR533)	
SB1.5 Select	1.5000v(Default)	SB 1.5 Select
NB 1.05 Select	1.0500v(Default)	1.5000v []
VDIMM Select	1.800v(Default)	1.5234v []
	
		2.1563v []
		↑↓:Move ENTER:Accept ESC:Abort
↑↓→← Move Enter:Select +/-/PU/PD:Value F10:Save ESC:Exit F1:General Help F5:Previous Values F6:Optimized Defaults F7:Standard Defaults		

Phoenix - AwardBIOS CMOS Setup Utility

Miscellaneous Control

CPU Clock Ratio unlock	Enabled	Item Help
CPU Clock Ratio	10X	
Auto Detect PCI Clock	Disabled	Menu Level >
Spread Spectrum	Disabled	
Current Host/PCI Clock is 133/33MHz		
Current DRAM Clock is 533MHz		
DRAM Clock at Next Boot	By SPD(DDR533)	
SB1.5 Select	1.5000v(Default)	NB 1.05 Select
NB 1.05 Select	1.0500v(Default)	1.0500v []
VDIMM Select	1.800v(Default)	1.0664 []
	
		1.5094v []
		↑↓:Move ENTER:Accept
		ESC:Abort
↑↓→← Move Enter:Select +/-/PU/PD:Value F10:Save ESC:Exit F1:General Help F5:Previous Values F6:Optimized Defaults F7:Standard Defaults		

Phoenix - AwardBIOS CMOS Setup Utility

Miscellaneous Control

<p>CPU Clock Ratio unlock Enabled CPU Clock Ratio 10X Auto Detect PCI Clock Disabled Spread Spectrum Disabled Current Host/PCI Clock is 133/33MHz Current DRAM Clock is 533MHz DRAM Clock at Next Boot By SPD(DDR533) SB1.5 Select 1.5000v(Default) NB 1.05 Select 1.0500v(Default) VDIMM Select 1.800v(Default)</p>	<p>Item Help</p> <hr/> <p>Menu Level ></p> <hr/> <p style="background-color: #0000FF; color: white; padding: 2px;">VDIMM Select</p> <hr/> <p style="background-color: #0000FF; color: white; padding: 2px;">1.800v []</p> <p style="background-color: #0000FF; color: white; padding: 2px;">1.825 []</p> <p style="background-color: #0000FF; color: white; padding: 2px;">.....</p> <p style="background-color: #0000FF; color: white; padding: 2px;">2.500v []</p> <hr/> <p style="background-color: #0000FF; color: white; padding: 2px;">↑↓:Move ENTER:Accept ESC:Abort</p>
<p>↑↓→← Move Enter:Select +/-/PU/PD:Value F10:Save ESC:Exit F1:General Help F5:Previous Values F6:Optimized Defaults F7:Standard Defaults</p>	

CPU Vcore

This item allows you select the CPU Vcore Voltage xx% more than the standard value, by this function for the precise over-clocking for extra demanding of performance.

VDIMM Voltage

This item allows you select the voltage of the memory.